

ADVANCE Directions for Use

FOLEY TRAY SYSTEM

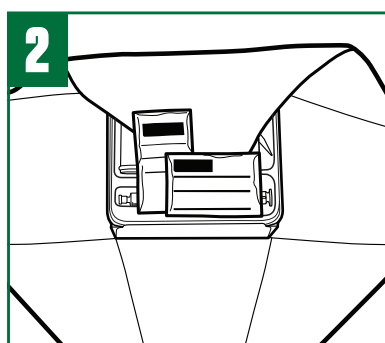

1 Wash hands and don clean gloves



2 Using proper aseptic technique open outer CSR wrap and remove components. Enclosed DFU will be under the tray



3 Place underpad beneath patient, plastic or "shiny" side down

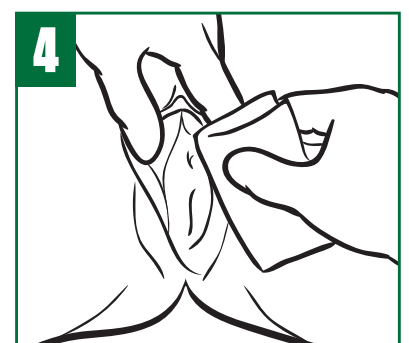

4 Use the provided packet of 3 castile soap wipes to cleanse patient's peri-urethral area

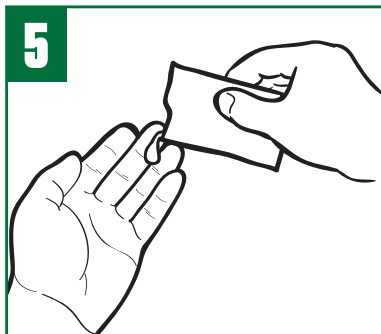

5 Discard gloves and perform hand hygiene with provided alcohol hand sanitizer gel

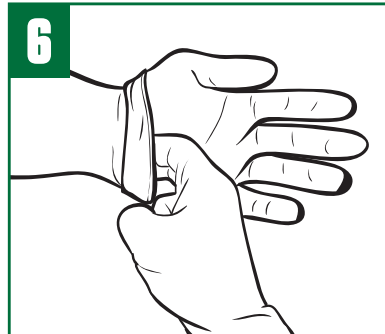

6 Don sterile gloves provided

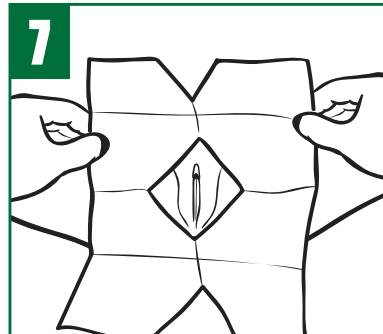

7 Position fenestrated drape on patient appropriately

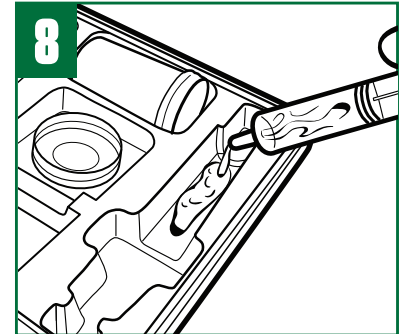

8 Using the syringe with the green plunger deposit lubricant into tray top compartment for lubricating the Foley catheter

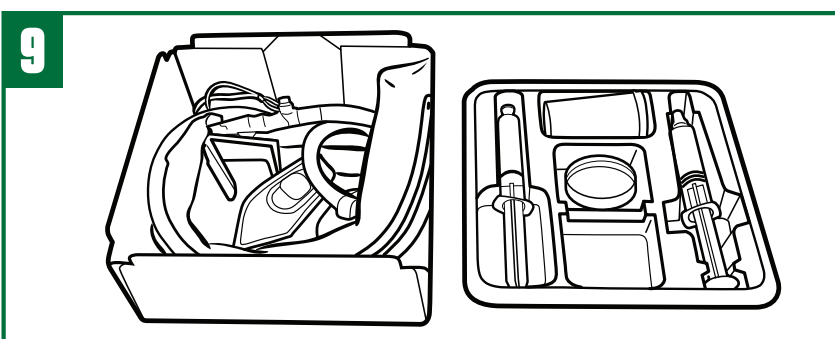

9 Remove top tray and place next to bottom tray (keep on CSR wrap)

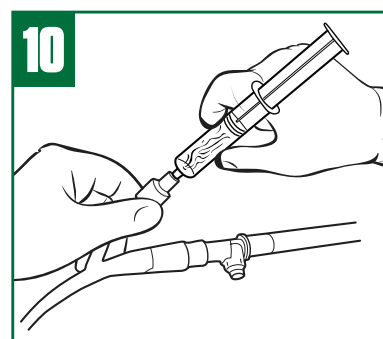

10 Attach the water filled syringe to the inflation port
NOTE: IT IS NOT NECESSARY TO PRE-TEST THE FOLEY CATHETER BALLOON

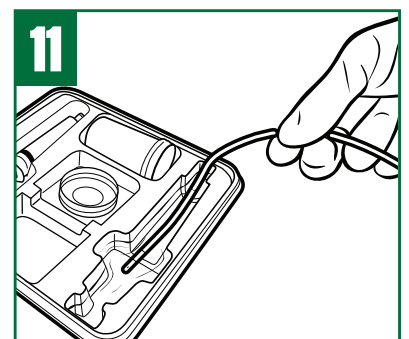

11 Remove Foley catheter from wrap and lubricate catheter

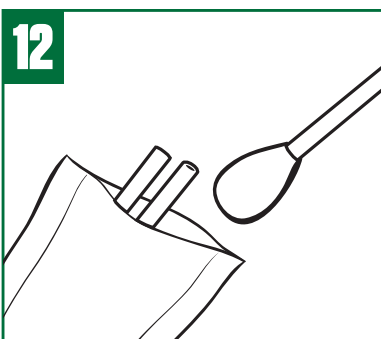

12 Prepare patient with packet of 3 pre-saturated antiseptic swab sticks

NOTE: Use each swab stick for one swipe only

Female Patient: with a downward stroke cleanse the right labia minora and discard the swab. Do the same for the left labia minora. With the last swab stick cleanse the middle area between the labia minora
Male Patient: Cleanse the penis in a circular motion starting at the urethral meatus and working outward

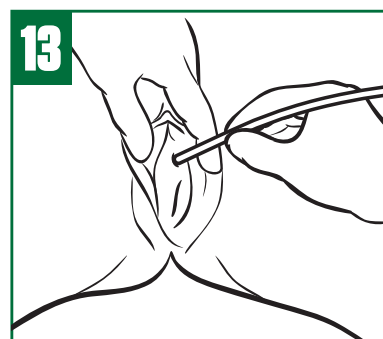
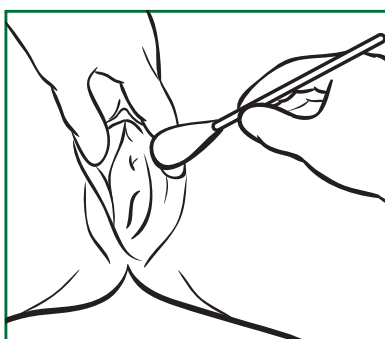

13 Proceed with catheterization in usual manner. When catheter tip has entered bladder, urine will be visible in the drainage tube. Insert catheter two more inches and inflate catheter balloon

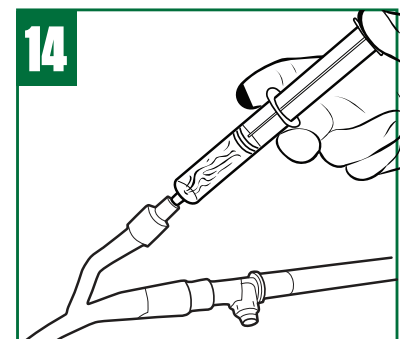

14 Inflate catheter balloon using entire 10cc of sterile water provided in the prefilled syringe
NOTE: USE OF LESS THAN 10cc CAN RESULT IN ASYMMETRICALLY INFLATED BALLOON

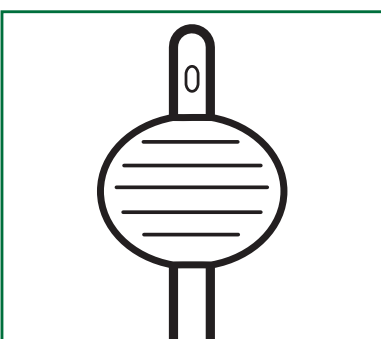

15 Properly Inflated with 10cc of sterile water

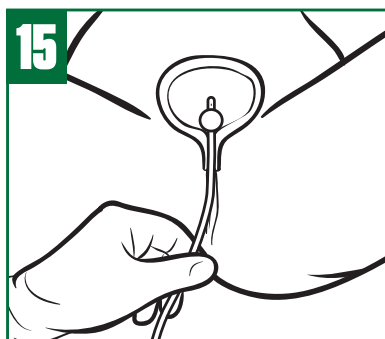

16 Once inflated, gently pull catheter until the inflated balloon is snug against the bladder neck

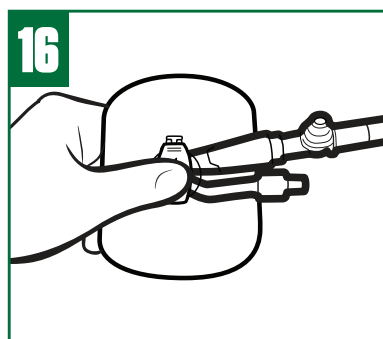

17 If provided, Secure the Foley catheter to the patient Using the STATLOCK® Foley Stabilization Device (see StatLock® Foley Stabilization Device IFU)
NOTE: PLEASE MAKE SURE PATIENT IS APPROPRIATE FOR USE OF STATLOCK® STABILIZATION DEVICE.

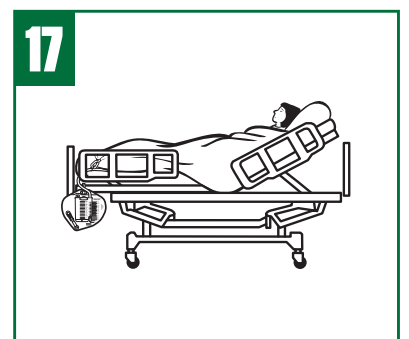

18 Position hanger on bed rail at the foot of the bed
NOTE: EXERCISE CARE TO KEEP BAG OFF THE FLOOR

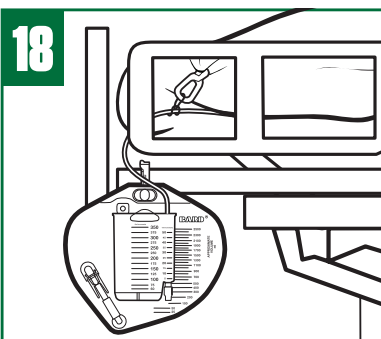

19 Use green sheeting clip to secure drainage tube to the sheet. Make sure tube is not kinked

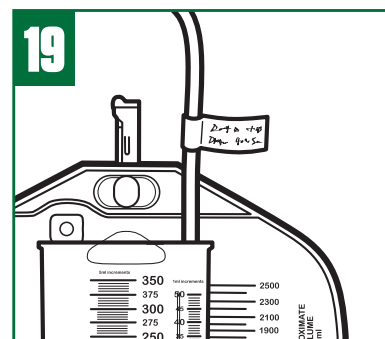

20 Indicate time and date of catheter insertion on provided labels. Place designated labels on patient chart and drainage system

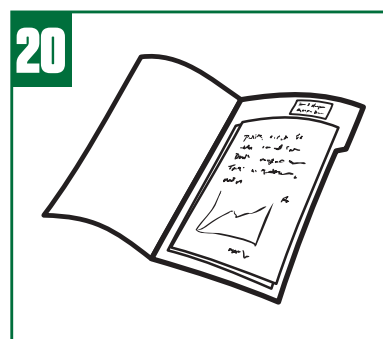

21 Document procedure according to hospital protocol

Foley Catheter Removal

1. To deflate catheter balloon: gently insert a luer lock or slip tip syringe in the catheter valve. Never use more force than is required to make the syringe "stick" in the valve
2. Allow the pressure within the balloon to force the plunger back and fill the syringe with water. If you notice slow or no deflation, re-seat the syringe gently

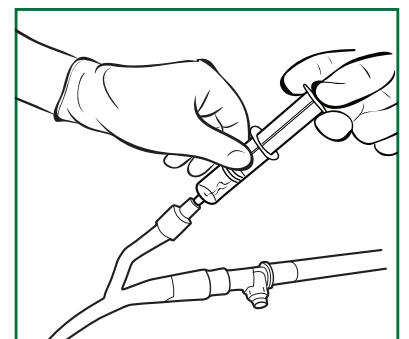

3. Use only gentle aspiration to encourage deflation if needed. Vigorous aspiration may collapse the inflation lumen, preventing balloon deflation
4. If the balloon will not deflate and if permitted by hospital protocol, the valve arm may be severed. If this fails, contact adequately trained professional for assistance, as directed by hospital protocol
5. Should balloon rupture occur, care should be taken to assure that all balloon fragments have been removed from the patient

BARD | MEDICAL

C. R. Bard, Inc. 8195 Industrial Blvd. Covington, GA 30014
1.800.526.4455 www.bardmedical.com

Sterile: Contents of inner wrap are sterile unless package has been opened or damaged.

Caution: Federal (U.S.A.) law restricts this device to sale by or on the order of a physician.

Single Use Only. Do not re-sterilize. For urological use only.

Warning: On catheter, do not use ointments or lubricants having a petrolatum base. They will damage the catheter and may cause balloon to burst.

Warning: After use, this product may be a potential biohazard. Handle and dispose of in accordance with accepted medical practices and applicable local, state and federal laws and regulations.

Visually inspect the product for any imperfections or surface deterioration prior to use. If package is opened or if any imperfection or surface deterioration is observed, do not use.

Bard, Bardex, EZ-Lok and StatLock are trademarks and/or registered trademarks of C. R. Bard, Inc.

Please consult product label and insert for any indications, contraindications, hazards, warnings, cautions and directions for use.

©2010 C. R. Bard, Inc. All Rights Reserved. Manufactured in USA.



BARD | MEDICAL